

## Wireless Liquid Level Gauge XY-LG270

### Typical Feature

- Measure range 0~100 meter
- With casting aluminum shell and SS304 Joint
- LCD display, white backlit
- Optional Wireless transmission GPRS/LORa/NB-iot
- Accuracy level: 0.5% FS; 1.0%FS
- Optional Power supply and battery
- Operating temperature -20°C ~ 60°C



### Brief Introduction

XY-LG270 Wireless Digital Level Gauge is a low power consumption design, powered by batteries. It is a liquid level measuring instrument with multiple wireless transmission modes, including GPRS/LORa/NB-iot, which is redesigned according to wireless digital pressure gauge with static pressure principle.

XY-LG270 is used Explosion-proof casting aluminum shell and 304 stainless steel connector joint, built-in high precision liquid level sensors, with LCD display screen, contact plunge-type liquid level probe by polyurethane cable, it can be installed easily, good waterproof performance.











It's easy to setup sampling and uploading data frequency, high- pressure and low-pressure alarm point and Instant pressure alarm, at the same time have many additional functions such as reset, backlit, on/off switch, converting unit, low liquid level alarm and so on.

As a wireless digital level gauge, it can upload liquid level data on site and cloud server, users can match IP address and other parameters on site or remotely.

The LORa type can work with LORa gateway, have the advantage of low power consumption, long transmission distance, strong signal penetration and AD hoc network.

The NB-iot type is a NB-iot transmission of wireless digital level meter, based on NB-iot technology, low power consumption, high transmission efficiency, low cost and other advantages.

### Suggested Applications

-  Fire protection water net
-  Heating system
-  Oil level of locomotive and oil tanker
-  Marine liquid level
-  Sewage treatment
-  Smart water management system
-  Medical equipment
-  Reservoirs and Ocean level
-  Civil pool and Water tank
-  River, lake, and pool level analyses
-  Urban water supply

**More details for XY-LG270, please contact us.**

Specification

<b>Model</b>	<b>XY-LG270</b>
Range	0-0.5-1-2-5-8-10-50M-100Meter H <sub>2</sub> O
Overload Capacity	200%
Measurement Medium	Oil or other Liquid with Compatibility of SS 304 or 316
Accuracy Level	0.5% FS;1.0% FS;
Long-Term Stability/Year	Typical: ±0.25% FS;
Transmitter Mode	GPRS LORa NB-iot
Display	LCD with white backlit
Sampling Frequency	1-60 Second/time optional
Upload Speed	1-1440 Minute
Alarm Point	Any pressure @whole measurement range
Operating temperature	-20~60°C;
Compensation	-20~60°C;
Power Supply	3.6 Lithium Battery or 12/24VDC Power supply
IP Protection Class	IP68
Installation Type	Immersed

Dimension(mm)

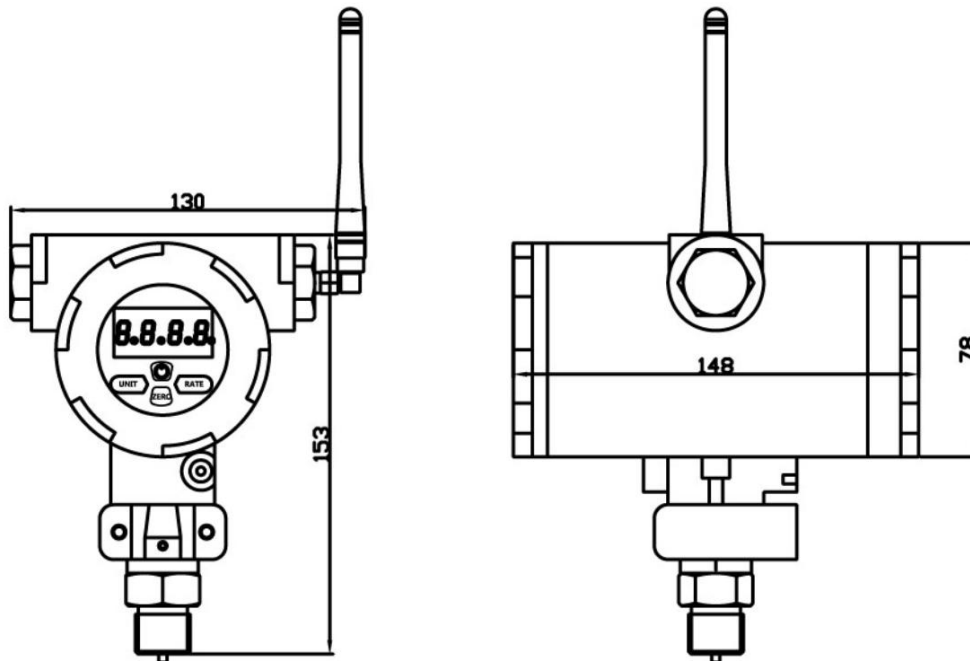

Mechanical Connection(mm)

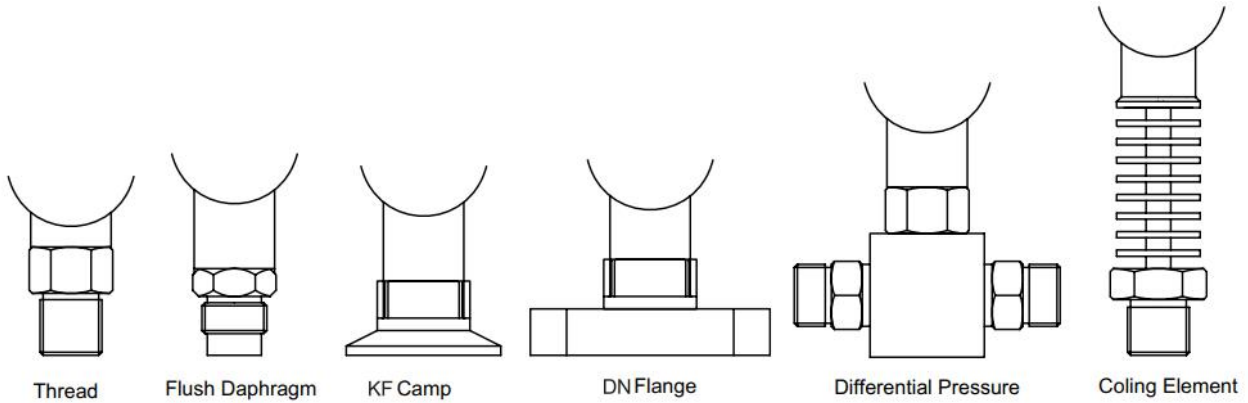

How To Order

XY-	LG	D	I	1M	1	P2	J	M3	B1	T1	L									
	Category	Type	Connection	Range	Accuracy	Power	Output	Thread	Electrical Connection	Medium Temperature	Additional									
LG	Liquid Gauge	D	Voltage Output	None	X(M)(0-X)Meter	P0	Battery	R	RS485	M1	M20*1.5	B	Cable Outlet	T1	-5~40°C	LC	LCD Display			
		R	RS485 Output	P		Diaphragm Seals	1	0.40%	P2	24V	A	4~20mA	M2	G1/4	C	Circular Connector	T2	-20~80°C	LE	LED Display
		270G	Wireless GPRS	DP		Differential Pressure	2	0.20%	P3	12~28V	V2	0~5V	M3	G1/2	E	IP 68 Waterproof Cable	T3	-20~65°C	I	Explosion-Proof
		270L	Wireless LoRa	KF		Clamp	3	0.10%	P5	380V			M4	1/2NPT	CC	Customized	T9	Customized		
		270H	Wireless NB-IoT	DN		Flange	4	0.50%	P6	12V			M5	1/4NPT						
LS	Liquid Sensor	1000	Submersible	I	Explosion-Proof Shell	5	0.25%	P6	12V			M6	Input							
		200	Lightning Protection	9999	Customized	8	Customized	P9	Customized			M7	25G1/4							
		500	Corrosive			9						M8	Customized							
		600	Mounted																	

If you may not find right information in this form, Please contact us to get future details

Shanghai XuYan Precision Technology Co., Ltd.

**Address:** No. 969, YunHan Road Pudong District Shanghai City China

**Tel:** +86 21 59241315

**Email:** sales@xvyanprecision.com

**Website:** [www.xvyanprecision.com](http://www.xvyanprecision.com)

**Product Manager:** Tyler Tou

**Cell:** +86 189 1797 0680

**Email:** ttao@Xuyanpercision.com