

Digital Pressure Switch XY-PS628E

Typical Feature

- Stainless steel 304 shell, dial diameter $\Phi 60\text{mm}$
- 4-Digits LED Display,
- Multi-unit convert MPa/Kgf/cm²/PSI
- Accuracy level:0.5%FS
- Power supply 24VDC; Optional 220VAC
- Dual relay, output signal NONC
- High precision, quick response time, stable and easy setting up



Brief Introduction











XY-PS628E is an Intelligent Digital Pressure Switch, with 60mm diameter stainless steel shell, integrating pressure measurement, display and control function. It has a variety of excellent functions, such as one-button reset, Multi-pressure Unit Converting and it's easy to reset setting, adjusting and installation.

Two relays are built in, this series of digital pressure switches have dual relays, which can be set up two ways of normally open and normally close alarm points separately, also are able to control two ways of high and low pressure of air or liquid, in addition, it is with one key reset, at the same time, calibration, shifting display unit, setting return difference and others option functions.

The intelligent pressure switch is equipped with high-precision instrument amplifier to amplify pressure signal, built-in temperature compensation sensor, is the high precision equipment for detecting and monitoring pressure, strong anti-electromagnetic interference (EMI), surge protection, reverse protection and so on

XY-PS628E Intelligent Digital Pressure Switch can be widely used in Automatic System, Mobile Working Machines, Medical Equipment, Pump, Compressor, Energy and Water Treatment, Agricultural Equipment, Test System, Hydraulic System and Pneumatic System.

Suggested Applications

-  Equipment Automation
-  Mobile Work Machine
-  Water Pump and Air compressor
-  Electromechanical Equipment Automation
-  Energy and Water Treatment System
-  Medical Equipment
-  Hydraulic and Pneumatic Systems
-  Agricultural Equipment
-  Test Jig
-  Customized Applications

More details for XY-PS628E, please contact us.

Specification

Model	XY-PG628E
Gauge Pressure Range	0~0.2~1.0~1.6~5~10~25~40~60~100~160MPa
Mirco Pressure Range	0~5~10~25~40~60~100KPa
Vacuum Pressure Range	-100~0KPa
Overload Capacity	200% (≤ 10 MPa); 150% (> 10 MPa)
Measurement Medium	Gas or oil or other Liquid with Compatibility of SS 304 or 316
Accuracy Level	0.5%FS;
Long-Term Stability/Year	Typical: $\pm 0.5\%$ FS;
Alarm Point	Any pressure @whole measurement range
Output	Relay; NONC
Load Capacity	220VAC 3A
Display	4 digits LED
Operating temperature	-20~80°C
Compensation	-10~70°C
Power Supply	Optional 12VDC or 24VDC
Electrical Protection	Anti-EMI; Reverse connection protection (Current Power Supply)
Sampling Frequency	3 times/Second
Standard Mechanical Joint	M20*1.5; NPT1/4, G1/4, Customized types
Electronic Connection	Circular Connector

Dimension(mm)

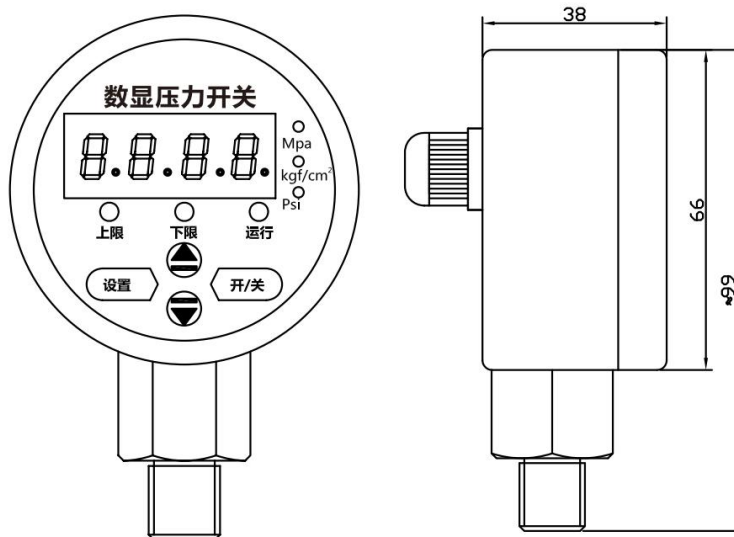

Output

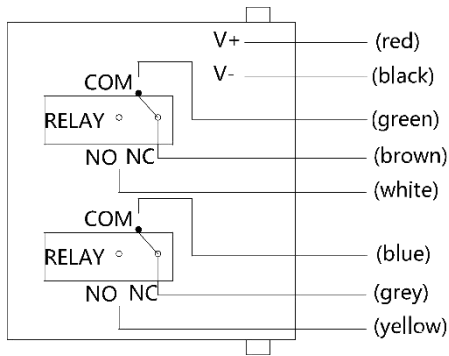

Function	Connection Method
Alternative Contact Pressure Gauge	Low Alarm Point: Brown
	High Alarm Point: Yellow
	Common Port: Green and Blue connect in parallel
Low Pressure Close, High Pressure Open	Output: Brown+Green
	Set AL and Hysteresis Ad1
Low Pressure Open, High Pressure Close	Output: Yellow+Blue
	Set AHand Hysteresis Ad2
Double High Pressure Alarm (High Pressure Close)	A Way: White+Green(Set AL)
	B Way: (Blue+Yellow(Set AH)

How To Order

XY-	PG	280	E	P	60M	I	P2	J	M3	B1	T1	L
Category	Type	Setup	Pressure Connection	Pressure Range	Accuracy	Power	Output	Thread	Electrical Connection	Medium Temperature	Additional	
PG Pressure Gauge	200 High Accuracy	E Lower Mount	None General Thread	XK (0-2KPa)	1 0.40%	P0 Battery	R RS485	M1 M20*1.5	B Cable Outlet	T1 -5~40°C	LC LED Display	
	210 High Accuracy Pressure&Temperature	Z Panel Mount	P Diaphragm Seals	XB (0-2Bar)	2 0.20%	P2 24V	A 4-20mA	M2 G1/4	C Circular Connector	T2 -20~80°C	LE LED Display	
	270 Explosion-Proof	G Wireless	DP Differential Pressure	XM (0-2MPa)	3 0.10%	P4 220V	J1 Relay	M3 G1/2	CC Customized	T9 Customized	LI Explosion-Proof	
	280 80mm Dial Size LCD Display	F Peak Record	RF Clamp	LC Customized	4 0.50%	P1 380V	J2 30A Relay	M4 1/2NPT				
	360 60mm Dial Size	V Vacuum Switch	DM Flange		5 0.25%	P6 12V	CC Customized	M5 1/4NPT				
	300 100mm Dial Size	W Water Pump Switch	9999 Customized		9 Customized	P9 Customized		M7 2G1/4				
	380 80mm Dial Size LED Display							M8 Customized				
	500 Digital Remote-Transmission											
	855 Contact 60mm Dial Size											
	825 Contact 80mm Dial Size											
PS Pressure Switch	608 60mm Dial Size											
	608 80mm Dial Size											
	928 100mm Dial Size											
	660 Switch Box with Plastic Shell											
	600 Switch Box with Full Metal Shell											
PC Pressure Control	600 60mm Dial Size											
	600 80mm Dial Size											
	900 100mm Dial Size											

Remark: 1. This form is for whole Pressure Measurement and Pressure Control products, please read Product Data Sheet to get reference informations
2. If you may not find right information in this form, Please contact us to get future details

Shanghai XuYan Precision Technology Co., Ltd.

Address: No. 969, YunHan Road Pudong District Shanghai City China

Tel: +86 21 59241315

Email: sales@xvyanprecision.com

Website: www.xvyanprecision.com

Product Manager: Tyler Tou

Cell: +86 189 1797 0680

Email: ttao@Xuyanpercision.com