

Digital Pressure Gauge XY-PG380E

Typical Feature

- Dial diameter 80 mm
- With 4-Digits LED Display.
- Accuracy level: 0.5%FS
- Weld measurement pressure range(0~160MPa), or customized
- Powered 12VDC, or 24VDC; 220VAC and 380VAC are optional
- Multi pressure multiunit switching (PSI/Kg.F/cm²/MPa)
- One key Reset



Brief Introduction





XY-PG380E is Digital Pressure Gauge with LED Display, which was built-in high accuracy pressure sensor, it displays real time pressure at short response time, the typical characteristics are high accuracy and excellent long-term stability, designed for Pressure Container, Air Compressor, Automated Machine, Heat Pump Industry, it's very good alternative for Mechanical Pressure Gauge.

The Digital Pressure Gauge has LED display with 4-Digits. There are 2 buttons on front panel to control Reset, Unit converting. It is easy to install in Pipeline, Isolation Tank or others connects device, easy to set up operating parameter. Working condition is -20~80°C.

It has 304 stainless steel shell and connect joint, can be used in measuring gas, liquid, oil and others medium it has very good shock resistance and long working life.

XY-PG380E Digital Pressure Gauge is powered by 12VDC or 24VDC, 220VAC and 380VAC are optional. There are weld Measurement Range 0~160MPa, others Measurement Ranges are optional. Machinal joint include Thread, Flush Diaphragm, Clamp, Flange, Radiator and Differential Two-way Fitting.

Suggested Applications

-  Pressure Container,
-  Air Compressor
-  Automated Machine
-  Heat Pump Industry
-  Customized Applications

More details for XY-PG380E, please contact us.

Specification

Model	XY-PG380E
Gauge Pressure Range	0~100KPa~1MPa~1.6~5~10~25~40~160MPa
Pressure Type	Gauge Pressure Test
Dimension	Diameter Φ80
Overload Capacity	150%
Measurement Medium	Gas or oil or other Liquid with Compatibility of SS 304
Accuracy Level	0.5%FS;

Long-Term Stability/Year	Typical: $\pm 0.5\%$ FS;
Sample Frequency	5 times/Second
Display	4-Digits LED
Operating temperature	-20~80°C
Compensation Temperature	-10~60°C
Power Supply	12VDC or 24VDC; 220VAC and 380 are optional
Power	$\leq 0.5W$

Dimension(mm)

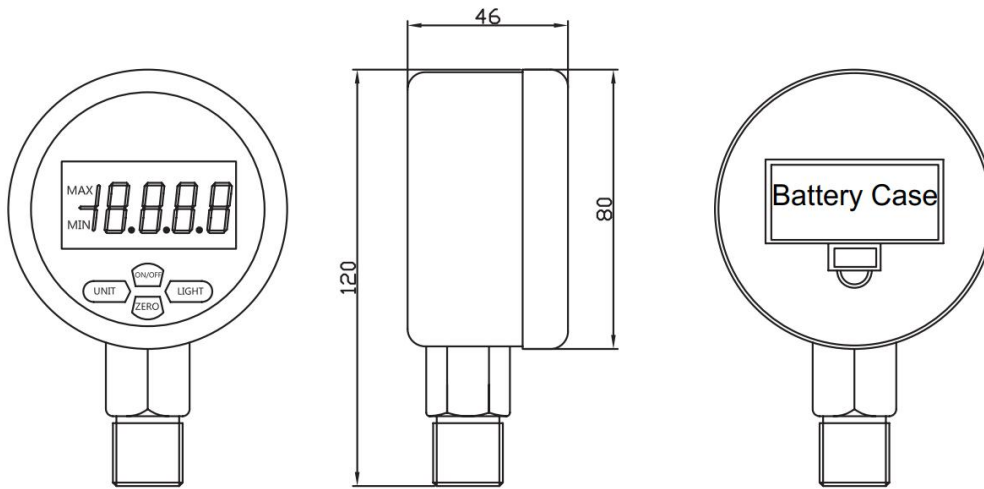

Mechanical Connection(mm)

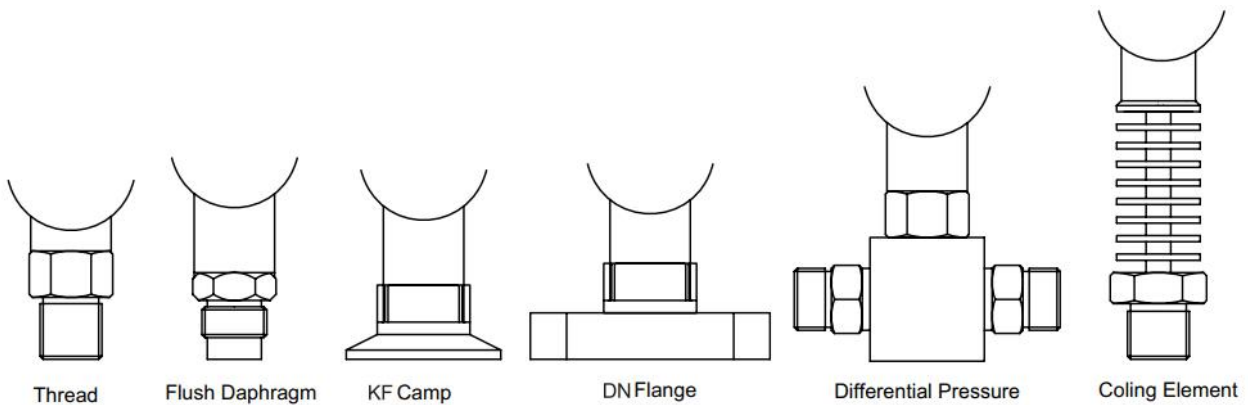

How To Order

XV-	PG	280	E	P	60M	1	P2	J	M3	B1	T1	L											
Category	Type	Setup	Pressure Connection	Pressure Range	Accuracy	Power	Output	Thread	Electrical Connection	Medium Temperature	Additional												
PG	Pressure Gauge	200	High Accuracy	E Lower Mount	None	General Thread	XX (0-30Pa)	1	0.40%	P0	Battery	R	RS485	M1	M20*1.5	B	Cable Outlet	T1	-5~40°C	LC	LCD Display		
		210	High Accuracy Pressure&Temperature	Z Panel Mount	P	Diaphragm Seals	XB (0-30Bar)	2	0.20%	P2	24V	A	4-20mA	M2	G1/4	C	Circular Connector	T2	-20~80°C	LE	LED Display		
		270	Explosion-Proof	G	Wireless	DR	Differential Pressure	XM (0-30MPa)	3	0.10%	P4	220V	J1	Relay	M3	G1/2	CC	Customized	T3	Customized	LI	Explosion-Proof	
		280	80mm Dial Size LCD Display	F	Peak Record	KF	Clamp	CC	Customized	4	0.50%	P5	380V	J2	Dual Relay	M4	1/2NPT						
		260	60mm Dial Size	V	Vacuum Switch	DN	Flange			5	0.25%	P6	12V	CC	Customized	M5	1/4NPT						
		300	100mm Dial Size	W	Water Pump Switch	9999	Customized			9	Customized	P9	Customized			M7	251/4						
		380	80mm Dial Size LED Display													M9	Customized						
		560	Digital Remote-transmission																				
		625	Contact 60mm Dial Size																				
		825	Contact 80mm Dial Size																				
PS	Pressure Switch	628	60mm Dial Size																				
		828	80mm Dial Size																				
		928	100mm Dial Size																				
		650	Switch Box with Plastic Shell																				
		600	Switch Box with Full Metal Shell																				
		700	Mechanical																				
PC	Pressure Control	600	60mm Dial Size																				
		800	80mm Dial Size																				
		900	100mm Dial Size																				

Remark: 1. This form is for whole Pressure Measurement and Pressure Control products, please read Product Date Sheet to get reference informations
2. If you may not find right information in this form, Please contact us to get future details

Shanghai XuYan Precision Technology Co., Ltd.

Address: No. 969, YunHan Road Pudong District Shanghai City China

Tel: +86 21 59241315

Email: sales@xvyanprecision.com

Website: www.xvyanprecision.com

Product Manager: Tyler Tou

Cell: +86 189 1797 0680

Email: ttao@Xuyanpercision.com