

Digital Contact Pressure Gauges XY-PG925M

Typical Feature

- Dial diameter 100mm, with Three 4-Digits LED Display
- Relay output, Normally Open, Normally Closed
- Accuracy level: 0.5%FS
- Weld measurement pressure range(-100KPa~160MPa)
- Powered 12VDC; 220VAC and 380VAC are Optional
- Multi pressure multiunit switching (PSI/Kg.F/MPa)
- One key reset, alarm indication for peak and valley
- Set up alarm in whole measurement range



Brief Introduction

XY-PG925M is Digital Contact Pressure Gauges, LED indicate Pressure, with same Electronic connection way with Mechanical Contact Pressure Gauge, which was built-in high accuracy pressure sensor, it displays real time pressure at short response time, the typical characteristics are high accuracy and excellent long-term stability, designed for Pressure Container, Air Compressor, Automated Machine, Hydraulic Machines and Plastic Injection Machines, it's very good alternative for Mechanical Contact Pressure Gauge.











The Contact Digital Pressure Gauges has three 4-Digits LED display, show Real Pressure data and Up Limit and Low Limit. There are 4 buttons on front panel to control Power On/Off and Setting. It is easy to install in pipeline, Isolation tank or others connects device, easy to set up operating parameter. Working condition is -20~80 °C.

It has 304 stainless steel shell and connect joint, can be used in measuring gas, liquid, oil and other medium it is very good shock resistance and long working life.

XY-PG925E Contact Digital Pressure Gauges is powered by 24VDC; 220VAC and 380VAC are optional. Load capacity is 220VAC 5A; 380VAC 3A; 24VDC 2A; They have good Anti-Electromagnetic Interference, Surge Protection and Reverse Polarity Protection to against Harsh Working Condition.

There are weld measurement range -100KPa~160MPa, others measurement range are optional. Machinal joint include Thread, Flush Diaphragm, Clamp, Flange, Radiator and Differential Two-way Fitting.

Suggested Applications

-  Automatic Equipment
-  Mobile Working Machines
-  Medical Device
-  Pressure Container
-  Air Compressor
-  Automated Machine
-  Heat Pump Industry
-  Energy and Water Treatment System
-  Test Jig
-  Hydraulic and Pneumatic System
-  Customized Applications

More details for XY-PG925M, please contact us.

Specification

Model	XY-PG925M
Gauge Pressure Range	-0.1~0~0.2~1.0~1.6~5~10~25~40~60~100~160MPa
Mirco Pressure Range	0~5~10~25~40~60~100KPa
Pressure Type	Gauge Pressure Test; Vacuum Pressure Test
Dimension	Diameter Φ60;
Overload Capacity	200% (≤10MPa); 150% (>10MPa)
Measurement Medium	Gas or oil or other Liquid with Compatibility of SS 304 or 316
Accuracy Level	0.5%FS;
Long-Term Stability/Year	Typical: ±0.5% FS;
Sample Frequency	5 times/Second
Display	4 Digits LED
Operating temperature	-20~80°C
Compensation Temperature	-10~50°C
Power Supply	24VDC; 220VAC and 380VAC are optional
Alarm Indication	Relay signal (Normally Open, Normally Closed)
Load Capacity	220VAC 5A; 380VAC 3A; 24VDC 2A
Electronic Connection	5 Pins Connivers

Dimension(mm)

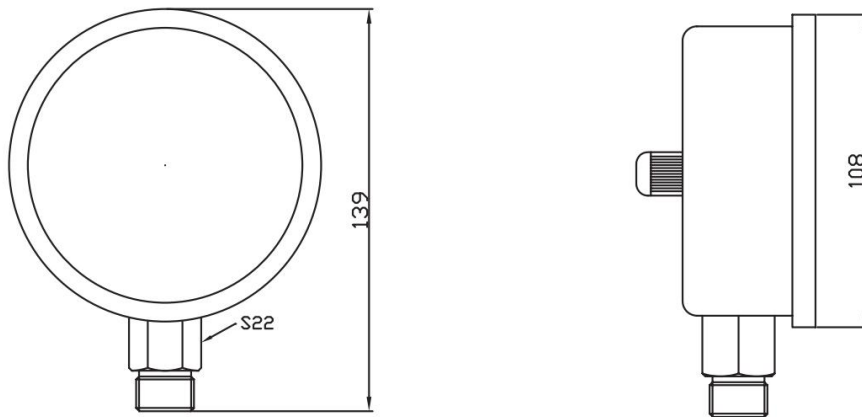

Mechanical Connection(mm)

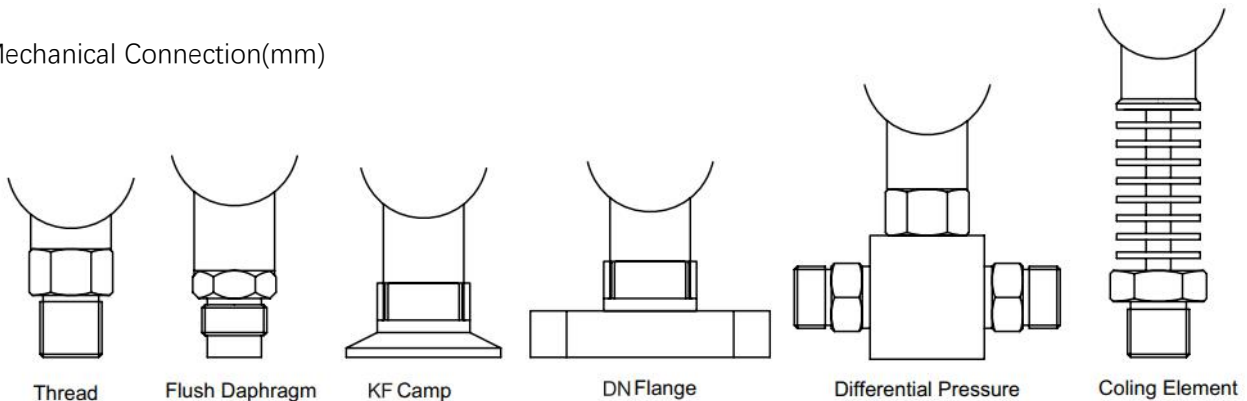

OUTLET LINE:

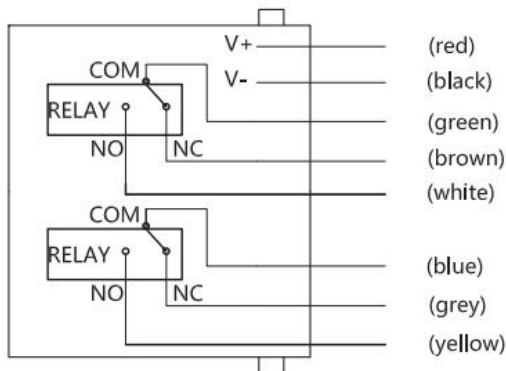

Function	Connecting Method
Replacement of digital electric contact pressure gauge	Low pressure alarm: brown High pressure alarm: yellow Common port: green+blue
Low pressure to contact high pressure to break	Output: brown+green Setting AL and hysteresis Ad1
Low pressure to break high pressure to contact	Output: yellow+blue Setting AH and hysteresis Ad2
Two groups high pressure alarm (high pressure to contact)	1 group: white+green (settingAL) 2 group: blue+yellow (settingAH)
eg: When pressure increases to 10 bar, the relay breaks; and decreases to 4 bar, the relay contacts. Use the 1 group relay to control, setting AL 4 bar and Ad1 6 bar. Use the 2 relay group to control, setting AH 10 bar and Ad2 6 bar.	

How To Order

XY	PG	280	E	P	60M	1	P2	J	M3	B1	T1	L
Category	Type	Setup	Pressure Connection	Pressure Range	Accuracy	Power	Output	Thread	Electrical Connection	Medium Temperature	Additional	
PG	Pressure Gauge	200 High Accuracy	E Lower Mount	None General Thread	X (0-0.1MPa)	1 0.40%	P0 Battery	R RS485	M1 M20*1.5	B Cable Outlet	T1 -5~40°C	LC LCD Display
		210 High Accuracy Pressure&Temperature	Z Panel Mount	P Diaphragm Seals	XB (0-3Bar)	2 0.20%	P2 24V	A 4-20mA	M2 G1/4	C Circular Connector	T2 -20~80°C	LE LED Display
		270 Explosion-Proof	G Wireless	DP Differential Pressure	XM (0-0.1MPa)	3 0.10%	P4 220V	J1 Relay	M3 G1/2	CC Customized	T9 Customized	EE Explosion-Proof
		280 80mm Dial Size LCD Display	F Peak Record	KF Clamp	CC Customized	4 0.50%	P5 360V	J2 Dual Relay	M4 1/2NPT			
		290 60mm Dial Size	V Vacuum Switch	D4 Flange		5 0.25%	P6 12V	CC Customized	M5 1/4NPT			
		300 100mm Dial Size	W Water Pump Switch	3999 Customized		9 Customized	P9 Customized		M7 2G1/4			
		380 80mm Dial Size LED Display							M9 Customized			
		560 Digital Remote-transmission										
		625 Contact 60mm Dial Size										
		925 Contact 60mm Dial Size										
PS	Pressure Switch	628 60mm Dial Size										
		828 80mm Dial Size										
		928 100mm Dial Size										
		650 Switch Box with Plastic Shell										
		680 Switch Box with Full Metal Shell										
PC	Pressure Control	680 60mm Dial Size										
		880 80mm Dial Size										
		980 100mm Dial Size										

Remark: 1. This form is for whole Pressure Measurement and Pressure Control products, please read Product Date Sheet to get reference informations
2. If you may not find right information in this form, please contact us to get future details

Shanghai XuYan Precision Technology Co., Ltd.

Address: No. 969, YunHan Road Pudong District Shanghai City China

Tel: +86 21 59241315

Email: sales@xvyanprecision.com

Website: www.xvyanprecision.com

Product Manager: Tyler Tou

Cell: +86 189 1797 0680

Email: ttao@Xuyanpercision.com